

12 GA. (.109" WALL)
 SPUN STEEL
 WITH 1 1/2" 'C' ROLLED EDGE

2" SQUARE
 STEEL TUBE

1 1/2" SQUARE
 STEEL TUBE

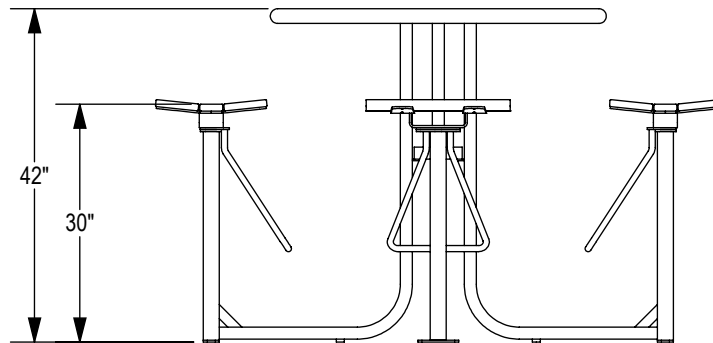
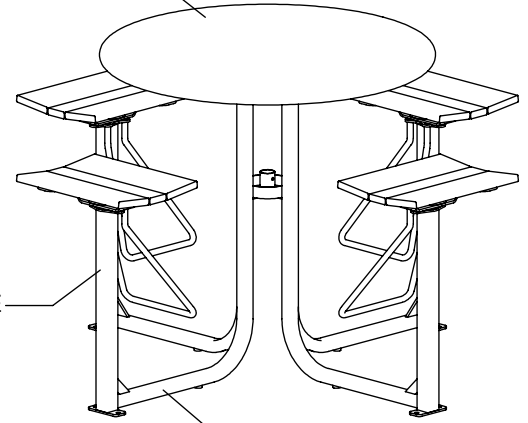

PRODUCT: LOTB-4F
 DESCRIPTION: LOFTY BAR HEIGHT TABLE, 4 FLAT SEATS

DATE: 11-13-18
 ENG: SMC

CONFIDENTIAL DRAWING AND INFORMATION IS NOT TO BE COPIED OR DISCLOSED TO OTHERS WITHOUT THE CONSENT OF GRABER MANUFACTURING, INC. SPECIFICATIONS ARE SUBJECT TO CHANGE WITHOUT NOTICE.

©2018 GRABER MANUFACTURING, INC. ALL PROPRIETARY RIGHTS RESERVED.

UMBRELLA HOLE OPTION

SOME ASSEMBLY REQUIRED

SITE FURNISHING IS POWDER COATED WITH TGIC POLYESTER. STEEL SURFACE PREP INCLUDES MECHANICAL AND CHEMICAL ETCHING FOLLOWED WITH A COATING TO IMPROVE ADHESION AND CORROSION RESISTANCE.