

12 GA. (.109" WALL)
 SPUN STEEL
 WITH 1 1/2" 'C' ROLLED EDGE

2" SQUARE
 STEEL TUBE

1 1/2" SQUARE
 STEEL TUBE

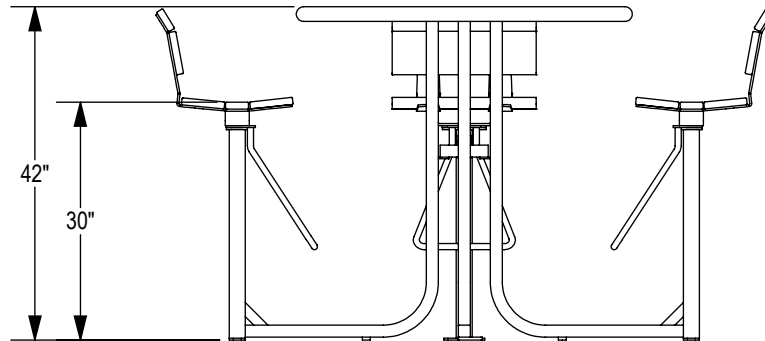
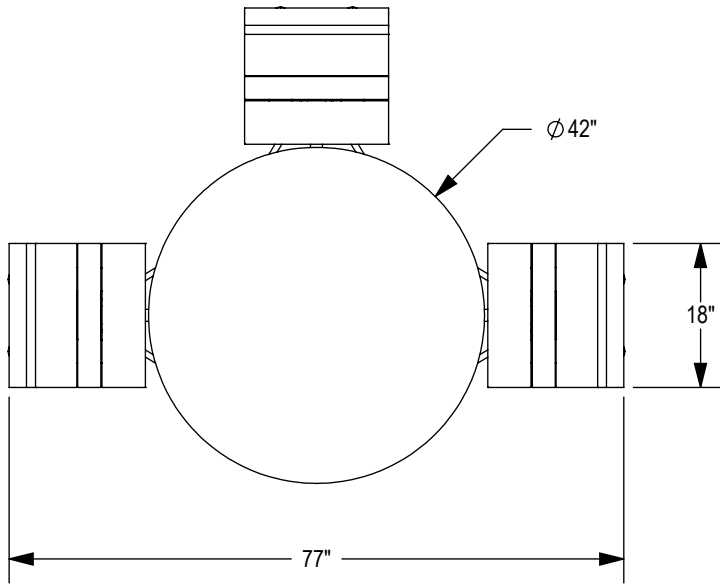
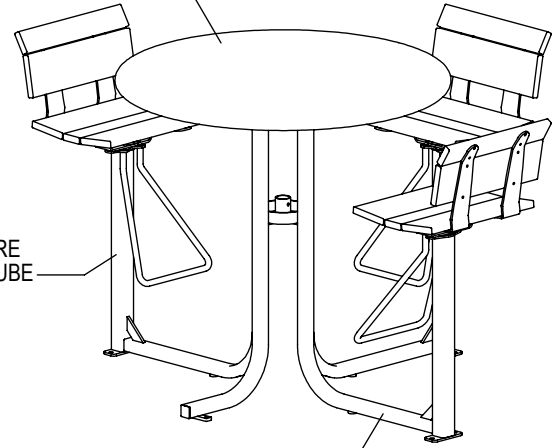

PRODUCT: LOTB-3B
 DESCRIPTION: LOFTY BAR HEIGHT TABLE, 3 BACKED SEATS

DATE: 11-12-18
 ENG: SMC

CONFIDENTIAL DRAWING AND INFORMATION IS NOT TO BE COPIED OR DISCLOSED
 TO OTHERS WITHOUT THE CONSENT OF GRABER MANUFACTURING, INC.
 SPECIFICATIONS ARE SUBJECT TO CHANGE WITHOUT NOTICE.

©2018 GRABER MANUFACTURING, INC. ALL PROPRIETARY RIGHTS RESERVED.

UMBRELLA HOLE OPTION

SOME ASSEMBLY REQUIRED

SITE FURNISHING IS POWDER COATED WITH TGIC POLYESTER.
 STEEL SURFACE PREP INCLUDES MECHANICAL AND CHEMICAL
 ETCHING FOLLOWED WITH A COATING TO IMPROVE ADHESION
 AND CORROSION RESISTANCE.