

PERFORATION DETAIL

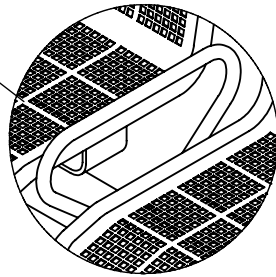

ARM OPTION - SPECIFY  
NUMBER OF ARMS DESIRED \_\_\_\_\_

3/4" ROUND STEEL ROD

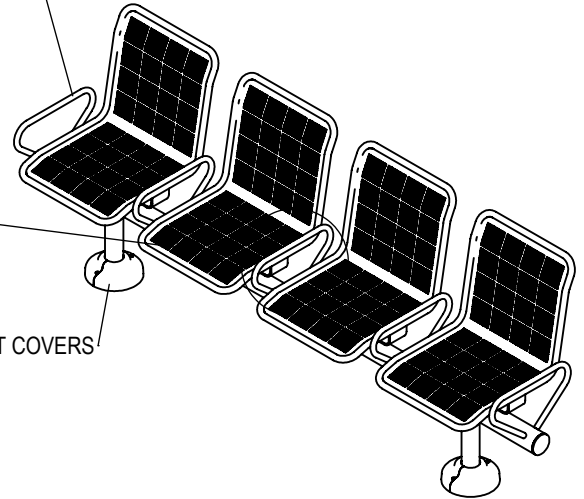

DIE CAST GROUT COVERS

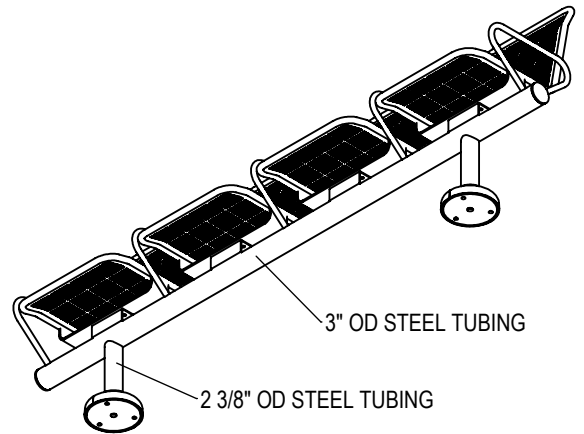
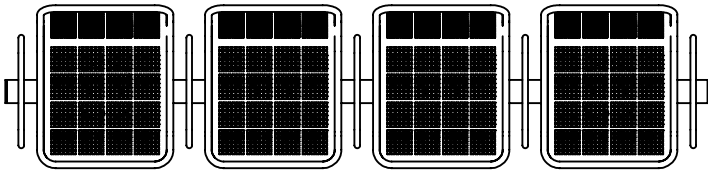

3" OD STEEL TUBING

2 3/8" OD STEEL TUBING

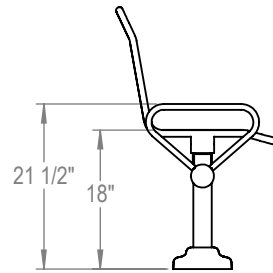
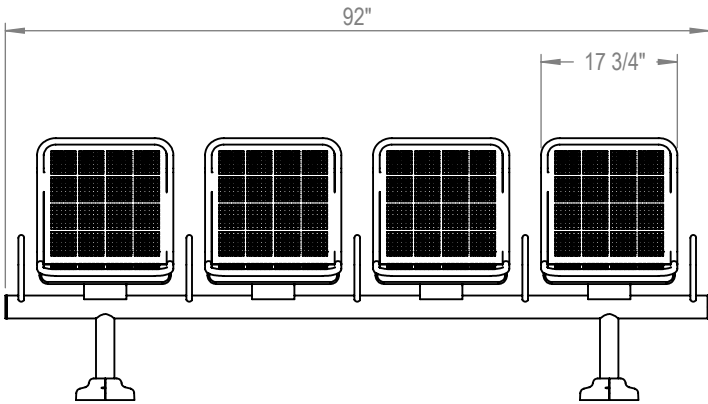

21 1/2"

18"

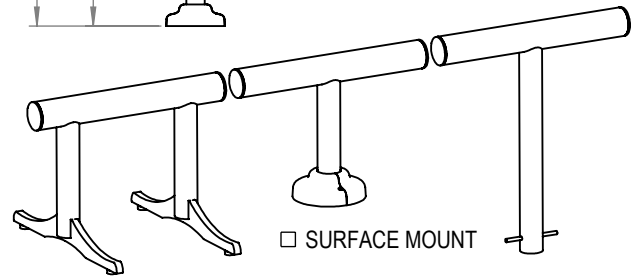

SURFACE MOUNT

FREE STANDING

IN GROUND

CHECK DESIRED MOUNT

PRODUCT: SSMB-4  
DESCRIPTION: STATE STREET BACKED MODULAR BENCH,  
4 SEAT

DATE: 10-6-15  
ENG: SMC

ALL FASTENERS ARE STAINLESS STEEL  
SOME ASSEMBLY REQUIRED

CONFIDENTIAL DRAWING AND INFORMATION IS NOT TO BE COPIED OR DISCLOSED  
TO OTHERS WITHOUT THE CONSENT OF GRABER MANUFACTURING, INC.  
SPECIFICATIONS ARE SUBJECT TO CHANGE WITHOUT NOTICE.

SITE FURNISHING IS POWDER COATED WITH TGIC POLYESTER.  
STEEL SURFACE PREP INCLUDES MECHANICAL AND CHEMICAL  
ETCHING FOLLOWED WITH A COATING TO IMPROVE ADHESION  
AND CORROSION RESISTANCE.