

1/4" X 1 1/2" FLAT BAR

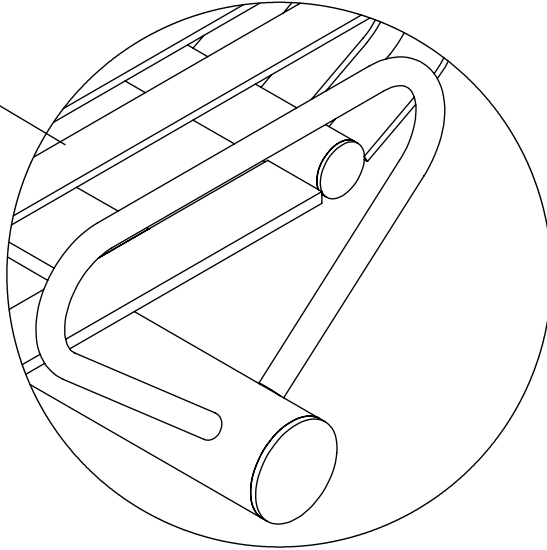

3/4" ROUND STEEL ROD

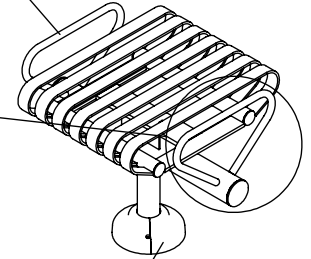

DIE CAST GROUT COVERS

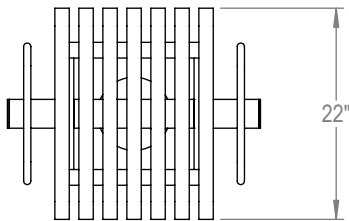

ARM OPTION - SPECIFY NUMBER OF ARMS DESIRED _____

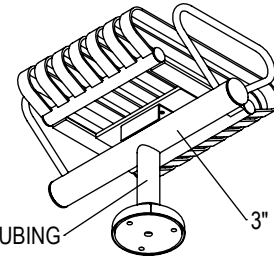

2 3/8" DIAMETER TUBING

3" DIAMETER TUBING

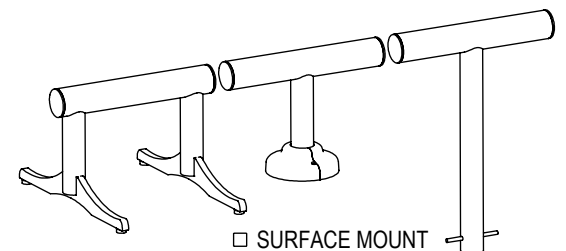
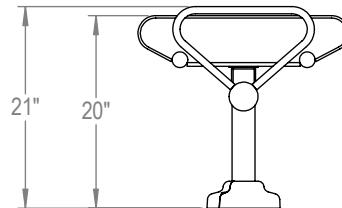
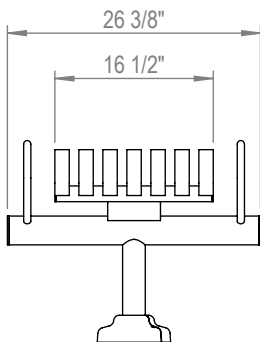

FREE STANDING

SURFACE MOUNT

IN GROUND

CHECK DESIRED MOUNT

ALL FASTENERS ARE STAINLESS STEEL
 SOME ASSEMBLY REQUIRED

PRODUCT: CRMF-1
 DESCRIPTION: CARNIVAL FLAT MODULAR BENCH,
 1 SEAT
 DATE: 6-14-16
 ENG: SMC

CONFIDENTIAL DRAWING AND INFORMATION IS NOT TO BE COPIED OR DISCLOSED
 TO OTHERS WITHOUT THE CONSENT OF GRABER MANUFACTURING, INC.
 SPECIFICATIONS ARE SUBJECT TO CHANGE WITHOUT NOTICE.

SITE FURNISHING IS POWDER COATED WITH TGIC POLYESTER.
 STEEL SURFACE PREP INCLUDES MECHANICAL AND CHEMICAL
 ETCHING FOLLOWED WITH A COATING TO IMPROVE ADHESION
 AND CORROSION RESISTANCE.