

ARM OPTION - SPECIFY
NUMBER OF ARMS DESIRED _____

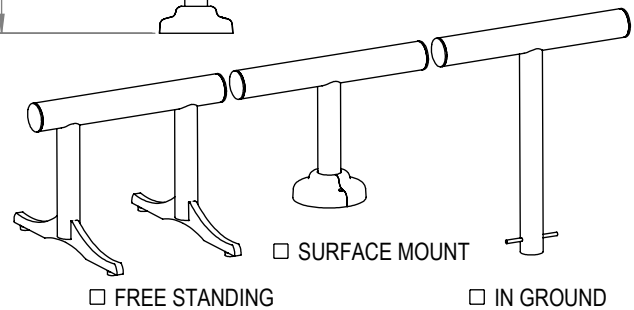
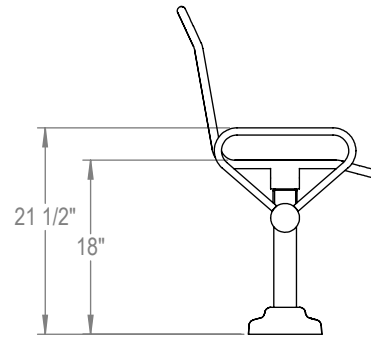
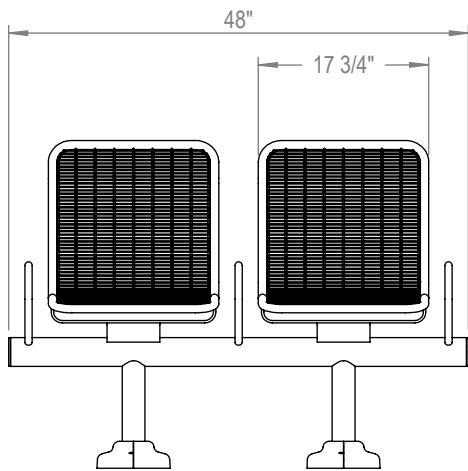
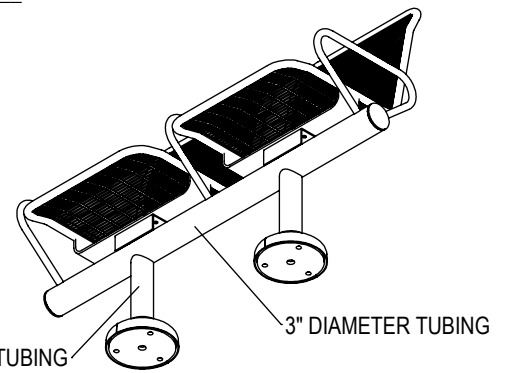
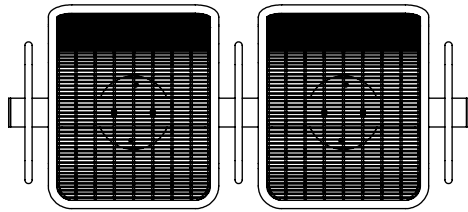

PRODUCT: CNMB-2
DESCRIPTION: CUNNINGHAM BACKED MODULAR BENCH,
2 SEAT
DATE: 10-6-15
ENG: SMC

ALL FASTENERS ARE STAINLESS STEEL
SOME ASSEMBLY REQUIRED

CHECK DESIRED MOUNT

CONFIDENTIAL DRAWING AND INFORMATION IS NOT TO BE COPIED OR DISCLOSED
TO OTHERS WITHOUT THE CONSENT OF GRABER MANUFACTURING, INC.
SPECIFICATIONS ARE SUBJECT TO CHANGE WITHOUT NOTICE.

SITE FURNISHING IS POWDER COATED WITH TGIC POLYESTER.
STEEL SURFACE PREP INCLUDES MECHANICAL AND CHEMICAL
ETCHING FOLLOWED WITH A COATING TO IMPROVE ADHESION
AND CORROSION RESISTANCE.