

SHOWN WITH TOP REMOVED

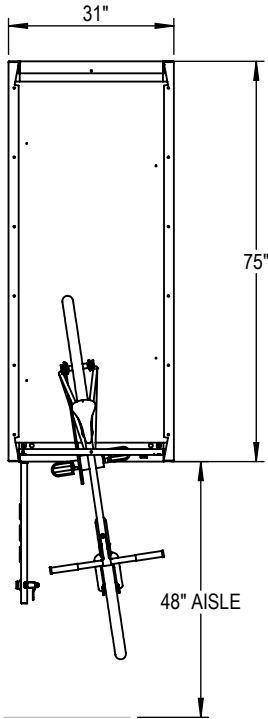

ALLOW FOR LOADING OF BIKE.
SUGGESTED CLEARANCE OF 60"
(MINIMUM OF 48")

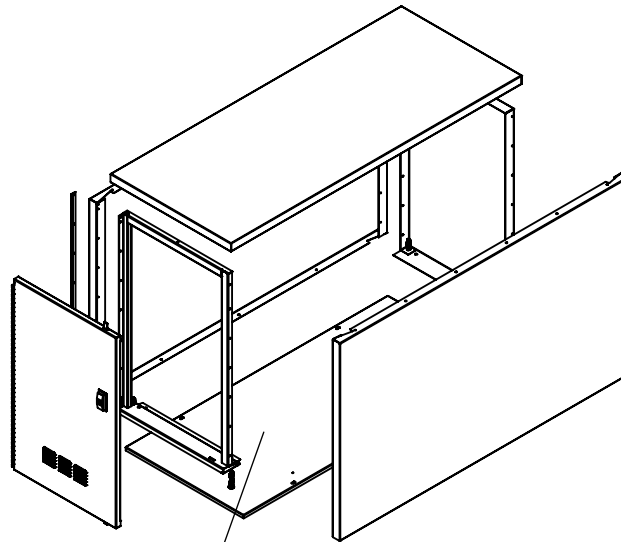

SHOWN WITH FLOOR OPTION

EXPLODED COMPONENT VIEW

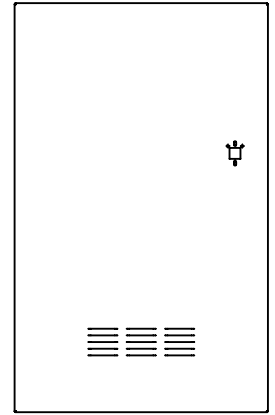

SOLID DOOR

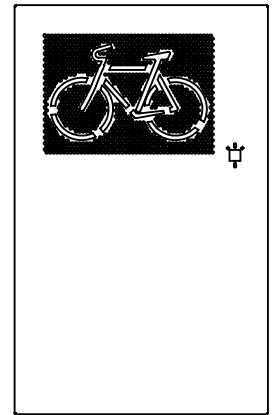

BICYCLE PERFORATION DOOR

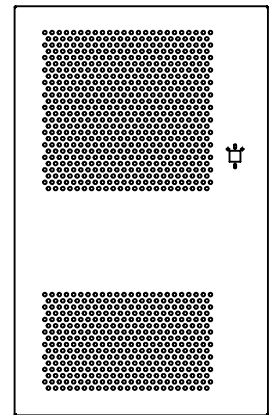
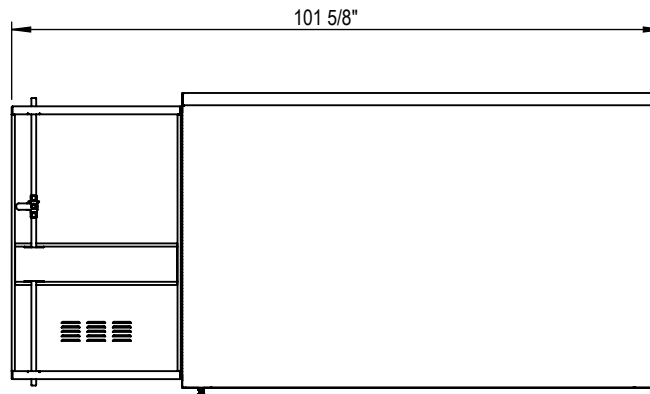
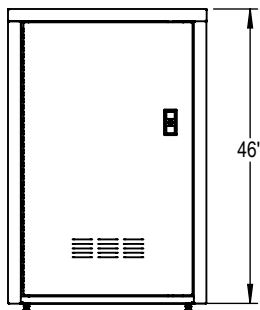

FULL PERFORATION DOOR

CHECK LOCKING STYLE

- HEAVY DUTY 4266 POP-OUT "T" HANDLE WITH 2 USER KEYS (KEYED DIFFERENTLY)
- STEEL U-LOCK AND PADLOCK STYLE HANDLE (PADLOCK AND U-LOCK NOT INCLUDED)

OTHER AVAILABLE OPTIONS:

- NUMBER PLATES
- GRAFFITI RESISTANT ADDITIONAL COATING

NOTES:

1. INSTALL BIKE RACKS ACCORDING TO MANUFACTURER'S SPECIFICATIONS.
2. CONSULTANT TO SELECT COLOR (FINISH), SEE MANUFACTURER'S SPECIFICATIONS.
3. SEE SITE PLAN FOR LOCATION OR CONSULT OWNER.

PRODUCT: MLN-1
DESCRIPTION: MADLOCKER™ NARROW BIKE LOCKER
1 UNIT, 1 BIKE CAPACITY

DATE: 10-2-18
ENG: SMC

CONFIDENTIAL DRAWING AND INFORMATION IS NOT TO BE COPIED OR DISCLOSED TO OTHERS WITHOUT THE CONSENT OF GRABER MANUFACTURING, INC. SPECIFICATIONS ARE SUBJECT TO CHANGE WITHOUT NOTICE.