

SHOWN WITH TOP REMOVED

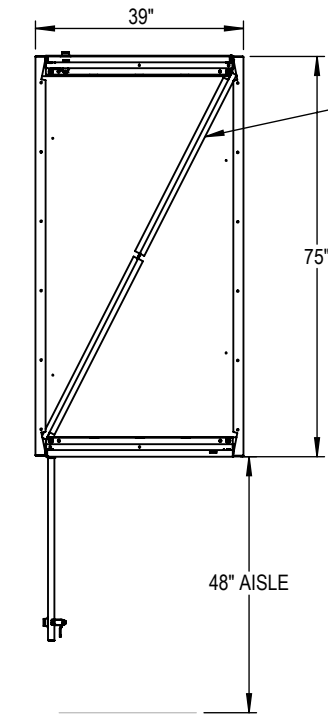

CENTER DIVIDER TO ALLOW FOR 2 BIKES

ALLOW FOR LOADING OF BIKE.  
SUGGESTED CLEARANCE OF 60"  
(MINIMUM OF 48")

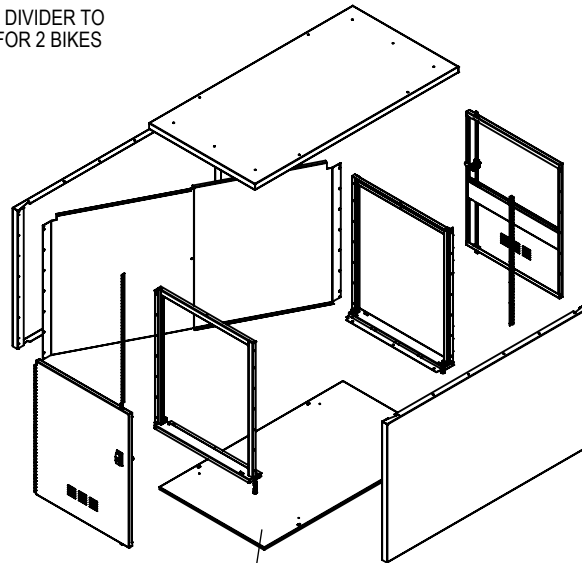

EXPLODED COMPONENT VIEW

SHOWN WITH FLOOR OPTION

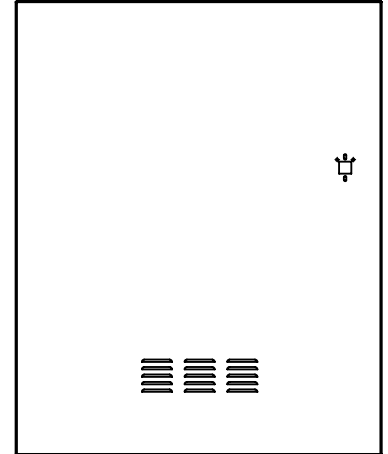

SOLID DOOR

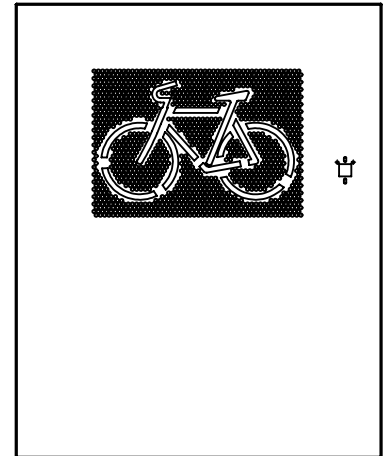

BICYCLE PERFORATION DOOR

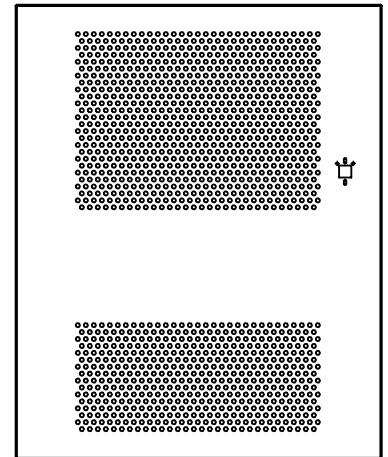

FULL PERFORATION DOOR

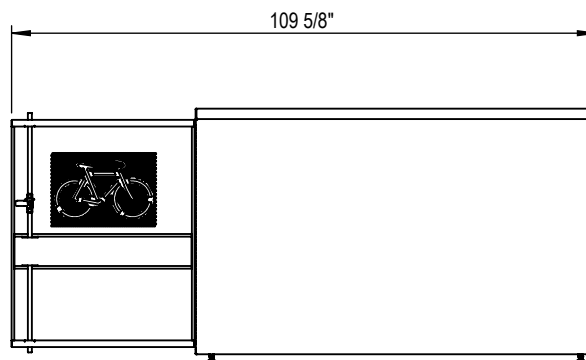
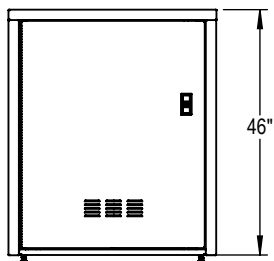

CHECK LOCKING STYLE

- HEAVY DUTY 4266 POP-OUT "T" HANDLE WITH 2 USER KEYS (KEYED DIFFERENTLY)
- STEEL U-LOCK AND PADLOCK STYLE HANDLE (PADLOCK AND U-LOCK NOT INCLUDED)

OTHER AVAILABLE OPTIONS:

- NUMBER PLATES
- GRAFFITI RESISTANT ADDITIONAL COATING

PRODUCT: ML2-2  
DESCRIPTION: MADLOCKER™ BIKE LOCKER  
1 UNIT - 2 DOOR, 2 BIKE CAPACITY  
DATE: 10-2-18  
ENG: SMC

CONFIDENTIAL DRAWING AND INFORMATION IS NOT TO BE COPIED OR DISCLOSED TO OTHERS WITHOUT THE CONSENT OF GRABER MANUFACTURING, INC. SPECIFICATIONS ARE SUBJECT TO CHANGE WITHOUT NOTICE.

NOTES:

1. INSTALL BIKE RACKS ACCORDING TO MANUFACTURER'S SPECIFICATIONS.
2. CONSULTANT TO SELECT COLOR (FINISH), SEE MANUFACTURER'S SPECIFICATIONS.
3. SEE SITE PLAN FOR LOCATION OR CONSULT OWNER.